

MASTERADIO D110, D110W

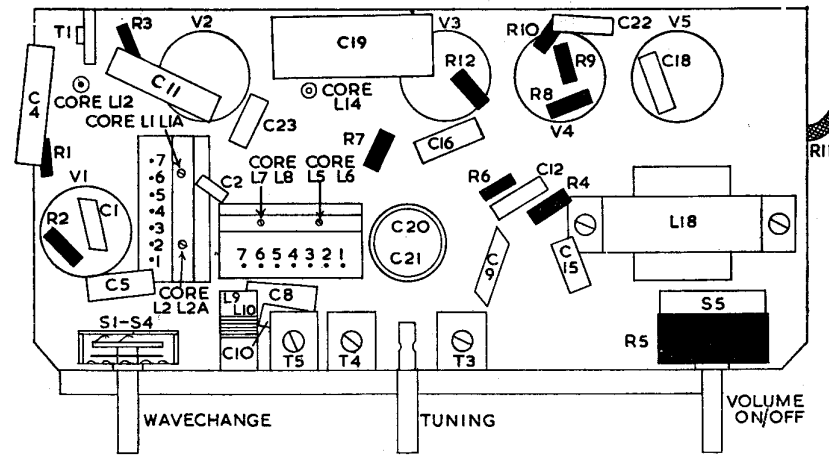

Five-valve three-waveband miniature superhet for 200-250V AC or DC mains. Permanently attached aerial wire. Walnut finished moulded cabinet or wood cabinet (D110W). Made by Masteradio, Ltd., 319-321, Euston Road, London, NW1.

V1 - 12K8GT

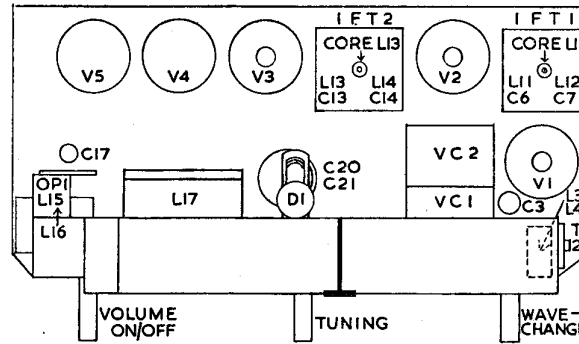
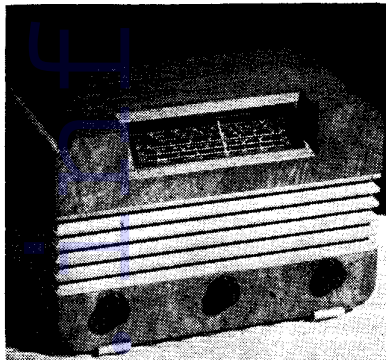
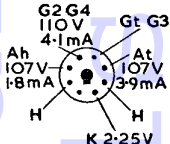

TOP CAP GRID I

V2 - 12K7GT

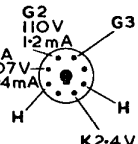

TOP CAP GRID I

V3 - 12Q7GT

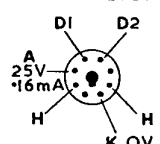

TOP CAP GRID

V4 - 35L6GT

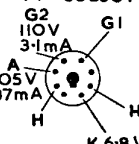

K 6-8V

V5 - 35Z4GT

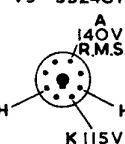

K 115V
57mA

DIAL LAMPS



6.2V .3A

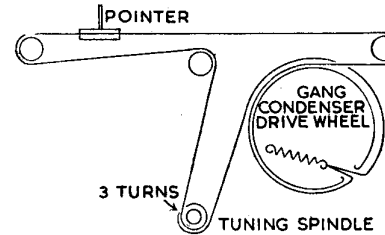

RESISTORS

R	Ohms	Watts
1	180	1/4
2	27K	1/4
3	47K	1/4
4	1M	1/4
5	500K Potentiometer with Switch	1/4
6	2M	1/4
7	470K	1/4
8	4.7K	1/4
9	470K	1/4
10	180	1/4
11	600 Special Tapped Linecord	1/4
12	47K	1/4

CAPACITORS

C	Capacity	Type
1	100pF Silver Mica	
2	56pF Ceramic	
3	.1 Tubular 350V	
4	.1 Tubular 350V	
5	100pF Silver Mica	
6	150pF Silver Mica	
7	150 pF Silver Mica	
8	600pF Silver Mica	
9	33pF Silver Mica	
10	100pF Silver Mica	
11	.1 Tubular 350V	
12	100pF Tubular Ceramic	
13	150pF Silver Mica	
14	150pF Silver Mica	
15	.01 Tubular 500V	
16	.01 Tubular 500V	
17	.01 Tubular 500V	
18	.01 Tubular 500V	
19	.25 Electrolytic 25V	
20	.24 Electrolytic 150V	
21	.16 Electrolytic 150V	
22	100pF Tubular Ceramic	
23	.01 Tubular 500V	

INDUCTORS

L	Ohms
1	3.5 between 5 & 6
1A	20 between 4 & 7
2	1.25 between 2 & 3
2A	5 between 1 & 4
3	.2
4	Very low
5	6 between 1 & 2
6	1.5 between 3 & 4
7	1.5 between 6 & 7
8	.1 between 4 & 5
9	Very low
10	.2
11	15
12	15
13	15
14	15
15	110
16	.5
17	2.5
18	140

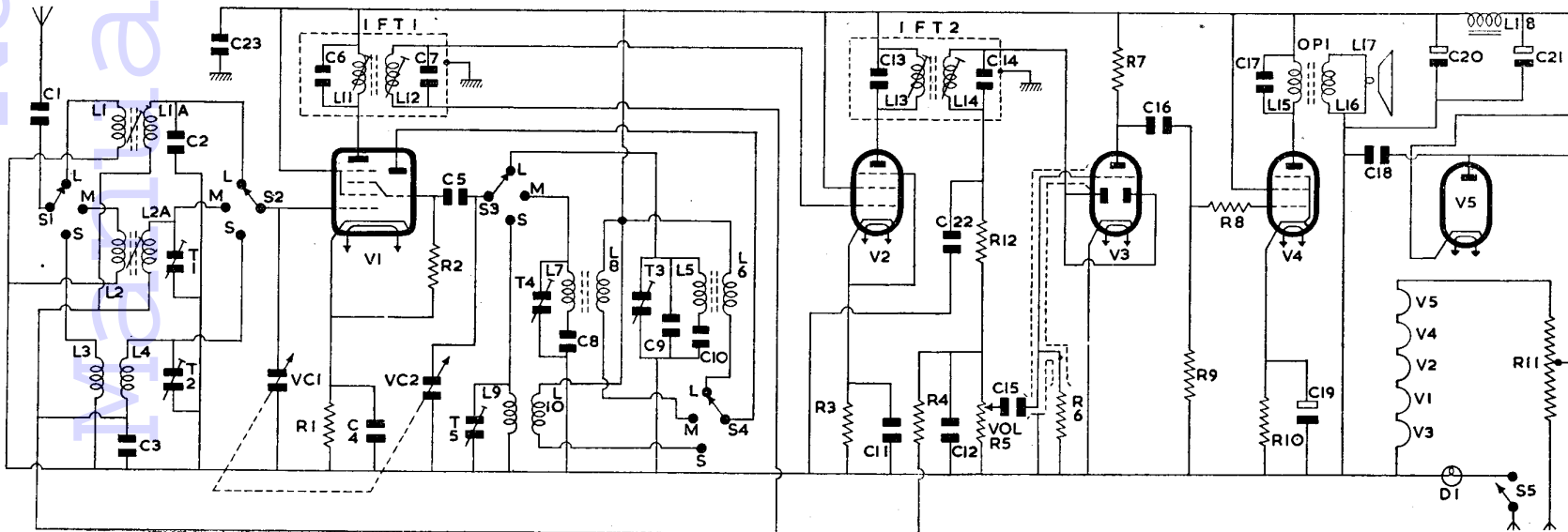

Continued on page 6

PHILCO BP427

CIRCUIT consists of a heptode frequency-changer V1 coupled by a permeability-tuned iron-cored transformer to an RF pentode IF amplifier V2. A second permeability-tuned IF transformer couples V2 to signal rectifier, AVC and AF amplifier valve V3. The AF amplifier portion of V3 is resistance-capacity coupled to the pentode output valve V4, which feeds a 6½-in. PM loudspeaker. HT of 90 volts and LT of 1.5 volts is provided by a combined battery, such as Ever-Ready "Batrymax" No. B.103 or Drydex type 503.

Aerial circuit consists of series-connected frame aerials L1 (MW), L2 (LW) and MW loading coil L3, which are tuned by VC1 and trimmed by T2 (MW), T1 (LW) and coupled to g3 of V1. S1 shorts out the LW frame L2 when it is switched to MW position. AVC is fed through tuned coils to g3 of V1 and is decoupled by C1. L7, C9, which form the primary of IFT1, are in the anode circuit of V1. R13 is an anode stopper.

Oscillator is connected in a tuned-grid parallel-fed HT circuit. L4 (MW), L6 (LW) are the grid coils and S2 switches them to tuning capacitor VC2 and through C3 to g1 of V1. T3 (MW), T4, C6 (LW) are trimmers and C5, C7 are padders. C2 is neutralising capacitor between sections of gang condenser.

Automatic bias for oscillator grid is developed on C3 with R1 as grid leak. Anode feedback voltages are developed inductively on L5 (MW) and capacitively across C7 (LW) and are switched by S3 through C4 to oscillator anode (g2, g4) of V1. R2 is anode load resistor.

IF amplifier operates at 465 Kc/s. L8, C10, the secondary of IFT1, applies signal and AVC voltages to grid of IF amplifier V2. Screen voltage is obtained from R3 and decoupled by C8. L9, C11, which form the primary of IFT2, are in the anode circuit.

Signal rectifier. L10, C12, the secondary of IFT2, applies signal to single diode of V3. R5, the volume control, is the diode load and R6A, C13, C14 constitute an IF filter.

AVC. The DC component of the rectified signal appearing across R5 is used for automatic volume control. R4 is AVC feed resistor and C1 decoupling capacitor.

AF amplifier. C15 feeds signal from volume control R5 to grid of pentode section of V3. Bias for grid is developed on C15 with R6 as grid leak. Screen voltage is obtained from R7 decoupled by C16. R8 is the anode load and C17 anode by-pass capacitor.

Output stage. C18 feeds signal to grid of output pentode V4. Negative bias for grid is obtained by connecting earthy end of grid resistor R11 to automatic bias resistor R12 in the negative HT return lead to chassis. C22 is bias decoupler. Screen voltage is obtained from R9 decoupled by C19. L11, the primary of OP1, the output matching transformer, is in the anode circuit of V4. C20 is for tone correction.

R10, connected between anodes of V3 and V4, introduces negative feedback voltages to input signal on grid of V4.

L12, the secondary of OP1, feeds signal to a 6½-in. PM speaker L13.

HT and LT are obtained from a combined 90V and 1.5V dry battery, such as Drydex type 503 or Ever-Ready Batrymax B.103. HT is decoupled

by C21. S4, ganged to the volume control spindle, breaks the HT negative lead to junction of R11, R12. Average HT consumption is 12-14 mA.

The filaments of V1 to V4 are connected in parallel and obtain their current of 240 mA from the 1.5V section of the battery. (The two halves of the 3V centre-tapped filament of V4 are also paralleled in order to operate from 1.5V supply).

Chassis removal. Remove the three push-on control knobs.

Remove back panel and unplug and remove battery. Unsolder the three leads from tags on frame aerial and also two leads to speaker output transformer OP1. Unscrew and remove the four chassis fixing bolts. Two of these secure chassis to top rear of cabinet and the other two fasten front edge of chassis to loudspeaker baffle plate.

TRIMMING INSTRUCTIONS

Apply signal as stated below	Tune Receiver to	Trim in Order stated for Max. Output
(1) 465 kc/s to g3 of V1 via .01 mF	190 metres	Core of L10, L9, L8, L7
(2) 1.4 mc/s to frame AE, via a loop	214 metres	T3, T2
(3) 600 kc/s as above..	500 metres	Core L4, L3, Repeat (2) and (3)
(4) 290 kc/s as above..	1034 metres	T4, T1
(5) 160 kc/s as above..	1875 metres	Core L6. Repeat (4) and (5)

Taylor Oscillograph

THE Taylor 30A oscillograph is a general purpose instrument operating from 100-120, 200-250V, 40-100 c/s mains and fitted with a 3¼-inch electrostatic tube. An internal timebase, with thyatron, covers 10-10,000 cycles, selected by a six-position switch and a variable control.

Another switch permits the timebase to be substituted by a 50 c/s or other external source. Amplitude of sweep is adjustable.

The timebase can be synchronised to the vertical deflecting signal, an internal 50 c/s supply, or to an external source. The sweep voltage is available for application to subsidiary equipment.

Waveform under examination is fed through a switched attenuating network, and variable gain control to an amplifier consisting of two EF36 valves providing push-pull output to the vertical deflecting plates. The amplifier has a reasonably linear response from about 10 c/s to 30 k/cs.

Direct coupling to both horizontal or vertical plates is possible. Shift controls have sufficient range to move the spot off the screen in any direction, and the focus control also has adequate range. The ON/OFF switch is ganged to the brightness control.

HT is provided by D4/60 tubular rectifier in a voltage doubling circuit. An astatically wound mains transformer cancels hum from the trace.

The oscilloscope is soundly constructed; all controls are clearly marked and sensibly positioned. We found the instrument exceedingly easy to use and thoroughly reliable.

In attractive steel case the instrument is made by Taylor Electrical Instruments, Ltd., Slough.

MASTERADIO D110,**D110W—from page 4**

CIRCUIT consists of a triode-hexode frequency-changer V1 coupled by a permeability-tuned iron-cored transformer to a variable-mu IF amplifier V2. A second permeability-tuned transformer couples V2 to the signal rectifier, AVC and AF amplifier valve V3 which, in turn, is resistance-capacity coupled to a beam tetrode output valve V4. The output is fed into a 3½-in. PM loudspeaker. HT is provided on AC mains supplies by a half-wave indirectly heated rectifier, V5.

Aerial. Approximately 9 ft. of PVC wire is permanently attached. Signal from aerial passes through isolating capacitor C1 to S1 and thence to aerial coupling coils L1 (LW), L2 (MW), L3 (SW). The aerial tuned coils L1A (LW), L2A (MW) and L4 (SW) are switched by S2 to tuning capacitor VC1 and to signal grid of V1. C2 (LW), T1 (MW) and T2 (SW) are trimmers.

AVC from R4 is applied through the tuned coils. C3 is AVC isolating and decoupling capacitor.

Cathode bias is provided by R1 decoupled by C4. Screen voltage is obtained from HT line. L11, C6, the primary of IFT1, is in the anode circuit.

Oscillator. A tuned-grid series-fed HT circuit contains L5 (LW), L7 (MW) and L9 (SW) as grid coils, which are switched by S3 to tuning capacitor VC2 and through C5 to oscillator grid. T3, C9 (LW), T4 (MW), T5 (SW) are trimmers and C10, C8 are LW and MW padders.

Negative bias for oscillator grid is developed on C5 with R2 as grid leak. Anode feedback is applied by L6 (LW), L8 (MW), L10 (SW), which are switched by S4 to oscillator anode of V1, the HT for which is fed through the coils.

IF amplifier operates at 465 kc/s. L12, C7, the secondary of IFT1, feed the signal to grid of V2. AVC from R4 is fed through L12 to grid. C3 is AVC decoupling.

Cathode bias is provided by R3 decoupled by C11. Screen voltage is obtained direct from HT line and suppressor grid is strapped to cathode. L13, C13, the primary of IFT2, are in the anode circuit.

Signal rectifier. L14, C14, the secondary of IFT2, feed signal to the strapped diodes of V3. R5, the volume control, is the diode load and R12 C12, C22 form an IF filter.

Automatic volume control is obtained from the DC component of the rectified signal across R5 and is fed through R4 to grids of V1 and V2. No delay voltage is provided.

AF amplifier.—C15 feeds signal from volume control R5 to grid of triode section of V3. Cathode is connected down to chassis and R7 is anode load resistor. Negative bias for grid is developed on C15 with R6 as grid leak.

Output stage.—C16 feeds signal from V3 anode to grid of beam tetrode output valve V4. R8 is stopper resistor and R9 grid resistor. Cathode bias is provided by R10, decoupled by C19. Screen voltage is obtained direct from HT line.

L15, the primary of OP1, the output matching transformer, is in the anode circuit with tone correction provided by C17. L16, the secondary of OP1, is coupled to a 3½-in. PM loudspeaker, L17.

High tension, when operating on AC mains, is provided by half-wave indirectly heated rectifier V5,

the anode voltage for which is obtained from the mains through part of line cord dropper resistor, R11. L18, C20, C21 provide choke-capacity smoothing and C23 affords RF decoupling of HT supply. C18 is fitted to eliminate modulation hum.

Heaters of V1 to V5 are series connected and obtain their current through dropper resistor, R11. The dial light is wired in series with the mains lead to chassis. S5, ganged to volume control spindle, is the ON/OFF switch.

Line cord.—The line cord is tapped approximately half-way down and the end of this tapping comes within an inch or so of the connector. When replacing connector plug, therefore, a careful check should be made to see that only the black lead and resistor wire are connected to the plug. In the receiver tested, a green wire was found to be twisted around the resistor wire. This wire is in no way connected to the line cord, but is inserted to preserve the shape of the cord throughout its length and is merely wrapped with the resistor wire to help ensure a good contact with plug connections.

Removal of chassis.—Uncoil aerial wire from back panel and remove panel. Remove the three control knobs. Remove adhesive seals over heads of chassis bolts on underside of cabinet. Remove chassis bolts and carefully withdraw chassis.

TRIMMING INSTRUCTIONS

Apply Signal as Below	Tune Receiver to	Trim in Order stated for Max. Output
(1) 465 kc/s to g1 of V1 via .01 capacitor	MW	Core of L14, L13, L12, L11
(2) 545 kc/s as above ..	550 metres	Core L7
(3) 1.5 mc/s as above ..	200 metres	T4. Repeat (2) and (3)
(4) 150 kc/s as above ..	2000 metres	Core L5
(5) 300 kc/s as above ..	1000 metres	T3. Repeat (4) and (5)
(6) 18.73 mc/s as above	16 metres	T5 to min. capacity peak
(7) 187.3 kc/s to junction of AE wire and C1 via 50 pF capacitor	1600 metres	Core L1A
(8) 1.3 mc/s as above ..	230 metres	T1
(9) 600 kc/s as above ..	500 metres	Core L2A. Repeat (8) and (9)
(10) 18.73 mc/s as above	16 metres	T2

Testing with Modern Instruments

A HANDBY guide to the use of modern test apparatus for finding faults and bringing receivers up to factory standards of performance is contained in "Radio Measurtests," a booklet issued by Marconi Instruments, Ltd., St. Albans, Herts, for trade engineers.

In 36 pages, the booklet supplements the instructions issued with the Marconi range of Measurtest instruments.

Whether or not an engineer possesses these particular instruments, he will find education and interest in the concise explanations of how receivers, amplifiers and loudspeakers should be checked and will gain an appreciation of the wide scope and fine precision of tests now available with up-to-date apparatus.