

For more information remember www.savoy-hi11.co.uk

# KOLSTER-BRANDES DR31

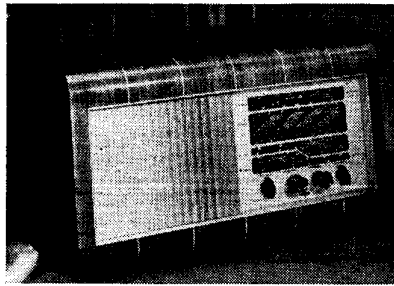

Four-valve four-waveband battery - operated superhet fitted with quiescent push-pull output stage. Short-wave ranges bandspread on 31 and 19 metres. Sockets for pickup and low-impedance extension loudspeaker. Made by Kolster-Brandes, Ltd., Footscray, Sidcup, Kent.

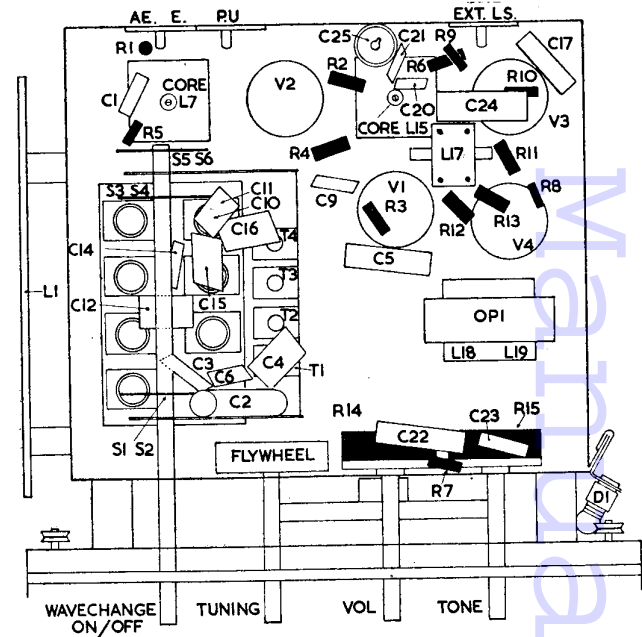
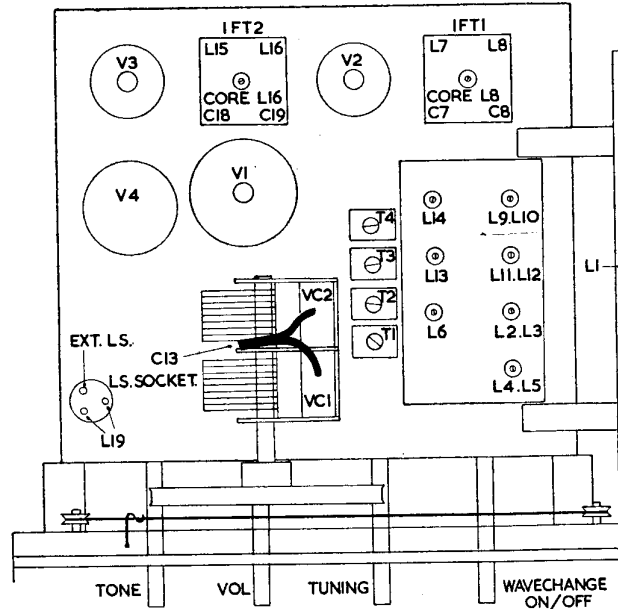
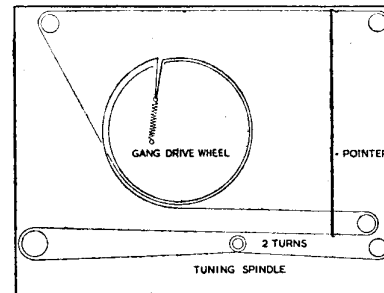
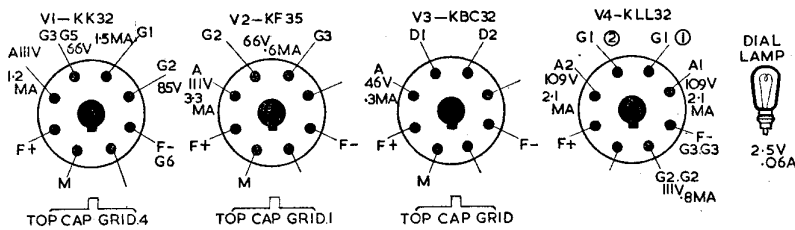

### CAPACITORS

C	Capacity	Type	C	Capacity	Type
1	.005	Tubular 500V	14	.230pF	Silver Mica
2	.1	Tubular 350V	15	.330pF	Silver Mica
3	3000pF	Silver Mica	16	400pF	Silver Mica
4	400pF	Silver Mica	17	.02	Tubular 350V
5	.02	Tubular 350V	18	150pF	Silver Mica
6	140pF	Silver Mica	19	150pF	Silver Mica
7	150pF	Silver Mica	20	15pF	Silver Mica
8	150pF	Silver Mica	21	100pF	Silver Mica
9	100pF	Silver Mica	22	.02	Tubular 350V
10	50pF	Ceramic	23	.001	Tubular 500V
11	90pF	Silver Mica	24	.1	Tubular 350V
12	430pF	Silver Mica	25	8	Electrolytic 150V
13	1pF	Formed with PVC Wire			

### RESISTORS

R	Ohms	Watts
1	4.7K	
2	22K	
3	100K	
4	10K	
5	470K	
6	47K	
7	4.7M	
8	220K	
9	470K	
10	470K	
11	1K	
12	220K	
13	220K	
14	500K	Potentiometer
15	500K	Potentiometer

### INDUCTORS

L	Ohms
1	1.4
2	Very low
3	Very low
4	Very low
5	Very low
6	18
7	5.2
8	5.2
9	Very low
10	Very low
11	Very low
12	Very low
13	4.5
14	8.7
15	5.2
16	5.2
17	8000: otal
18	800 total
19	Very low
20	2.5

Continued on page 12

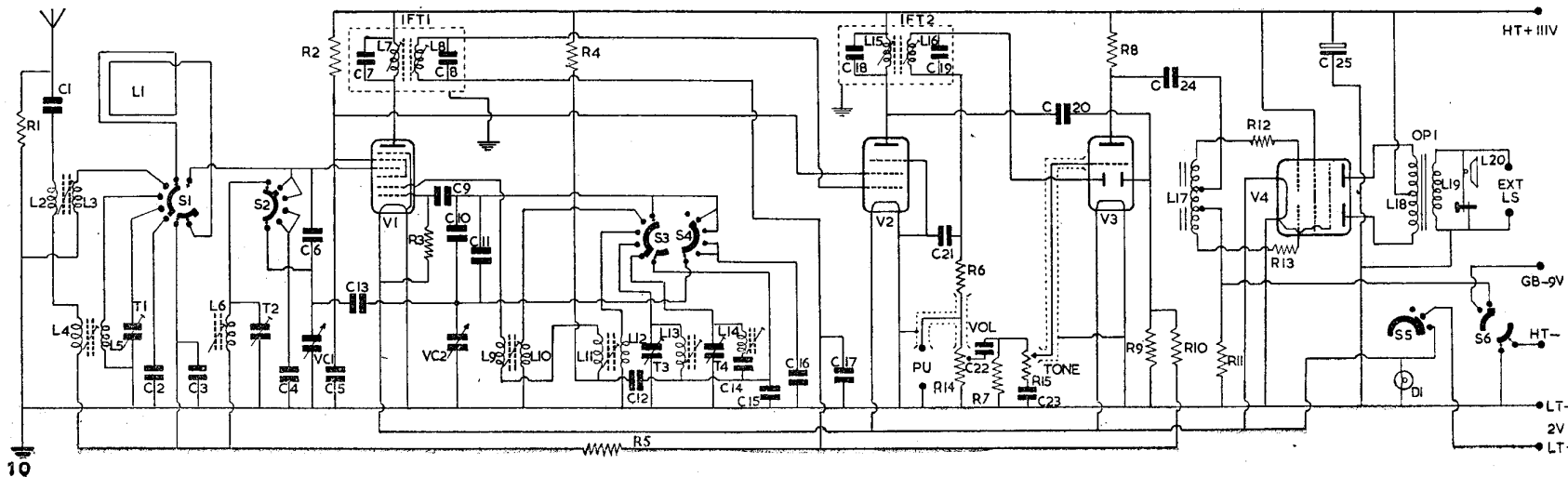

For more information remember www.savoy-hill.co.uk

## RI MODEL 493

anode circuit. L8 (SW), L10 (MW), and L12 (LW) are the anode coils, and these are switched by S6 to tuning capacitor VC2 and through C10 to oscillator anode of V1. T4 (SW), T5 (MW), T6 (LW) are trimmers, and C7, C6, C5 padders. S8 earths the anode coils not switched in circuit.

The grid reaction coils L7 (SW), L9 (MW), L11 (LW) are switched by S5 through C9 to oscillator grid. R6, R7, R8 are series limiters. Automatic bias for oscillator grid is developed on C9 with R5 as grid leak. S7 earths grid coils not in circuit.

**IF amplifier** operates at 450 Kc/s. L15, T8, which form the secondary of IFT1, feed signal and AVC voltages to g1 of variable mu RF pentode V2. R21 is AVC feed resistor, and C19 decoupling capacitor. Cathode bias is by R11, C14; screen voltage by R4, C12. Suppressor is strapped to cathode. L16, T9, the primary of IFT2, is in the anode circuit of V2.

**Signal rectifier.** L17, T10, the secondary of IFT2, feeds signal to one of diodes of V3. R14 is the load, and R15, C15, C16 form a filter.

**AVC.** C18 feeds signal from anode V2 to second diode of V3. R22, R20 form a tapped diode load. Full AVC voltage is fed by R23, R1 to g1 of V1. R21 feeds approximately half the AVC voltage to g1 of V2. C3, C19, C20 are for decoupling. Delay voltage is the cathode bias.

**Pickup.** The IF amplifier V2 is used to provide additional amplification of the pickup signal. When S9 is switched to gram. position, then AVC line is disconnected from bottom of L15 and a grid resistor R12, with pickup connected across it, is connected in its place. R10 in the anode of V2, which on radio is used as an HT decoupling resistor, has its associated capacitor C11 switched by S10 from earth to the top of volume control R13. Thus, when S10 is switched to gram. position, R10, C11 become anode load and coupling respectively. C13 provides AF decoupling of cathode bias resistor R11.

**Output stage.** C17 feeds radio signal to volume control R13 and thence, through stopper resistor R16, to grid of output pentode section of V3. Bottom end of R13 is returned to junction of R18, R19, and therefore cathode bias for pentode section of V3 is developed on R18. The full bias across R18 and R19, decoupled by C23, provides delay voltage for AVC diode.

L18, the primary of OP1, the output matching transformer, is in the anode of V3. R17 is anode stopper, and R24, C21 provide tone control.

L19, the secondary of OP1, feeds into a 6 1/2 in. energised speaker L20. L21 is a hum bucking coil connected in series with L20.

Sockets are provided for a low-impedance permanent-magnet extension speaker. Special extension sockets enable the internal and external speakers to be operated separately or together. Switch S11, incorporated in one of the sockets, is operated when the extension speaker plugs are inserted.

**High tension** is provided by an indirectly heated full-wave rectifier V4. L23 supplies its heater current, and L24 its anode voltages. Choke capacity smoothing is provided by L22, the field winding of the loudspeaker, and C24, C25.

**Heaters of V1 to V3 and Dial Lights** obtain their current from L25. L26, the primary of mains input transformer, MT1, is tapped for 200-250V 40-60 c/s mains supplies.

TRIMMER LAYOUT.

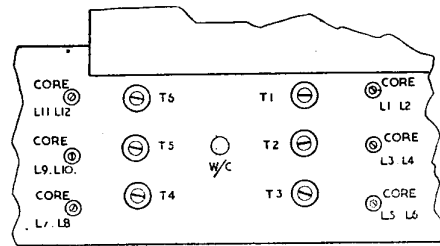

### TRIMMING INSTRUCTIONS

Apply signal as stated below	Tune Receiver to	Trim in Order stated for Max. Output
(1) 450 kc/s to g1 of V1, via .01 mF	MW band, and S/c VC2	T10, T9, T8, T7
(2) 16.6 mc/s to AE socket, via dummy aerial	18 Metres	T4, T1
(3) 6.4 mc/s as above...	47 metres	Core L8, L2 and repeat (2) and (3)
(4) 1.303 mc/s as above	230 metres	T5, T2
(5) 588 kc/s as above...	510 metres	Core L10, L4, and repeat (4) and (5)
(6) 353 kc/s as above...	850 metres	T6, T3
(7) 162 kc/s as above...	1850 metres	Core L12, L6, and repeat (6) and (7)
(8) 450 kc/s as above...	—	Core L13 for minimum

**Gramophone unit** is a Garrard model "S" fitted with shaded pole non-synchronous induction motor designed to operate on 100-130, 200-250V AC mains. The turntable is rim-driven by the motor through a friction pulley. The size of this pulley decides the speed of revolution of the turntable. The pulley normally fitted is designed for 78 rpm at a mains frequency of 50 c/s. Pulleys for 40 and 60 c/s supplies are available when required.

A magnetic pickup of 2,000 ohms impedance is fitted. The start/stop switch is operated by trip lever attached to the pickup arm, and the switch is operated when the pickup reaches a certain radius groove and not by the normal run-off groove.

**Motor maintenance.** The bearings of the motor and pulley are of the oil retaining type and should need little attention. When necessary a few drops of fine machine oil is all that is necessary. The rubber tyre on the intermediate pulley must be kept free of any trace of oil.

**Chassis removal.** Remove the four control knobs and the wood screws holding tone control bracket to front of case. Unplug speaker and pickup leads and remove three-way mains lead of receiver from junction box on baseboard of cabinet.

Remove the two chassis bolts on underside of cabinet. Carefully turn chassis so that dial plate faces right-hand side of cabinet (viewed from rear) and then withdraw chassis.

## K-B MODEL DR31—from page 10

**CIRCUIT** consists of an octode frequency-changer V1 coupled by permeability-tuned IF transformer to the IF amplifier V2. A second permeability-tuned IF transformer couples V2 to the signal rectifier, AVC and AF amplifier V3. The output from V3 is applied to a quiescent push-pull double pentode output valve V4. An eight-inch PM loudspeaker is fitted, and power is provided by a standard HT battery (111V plus 9V grid bias) and a 2V accumulator.

**Aerial.** An internal frame aerial L1 provides for local station reception. On LW it is used as a loop aerial, and on MW it constitutes the tuned coil. On the two SW bands it acts as a capacity aerial.

When an external aerial is used the signal is fed through C1 to the primaries L2, L4 of the SW coils and thence to bottom end of tuned coils L1 (MW), L6 (LW). S1 switches the tuned coils L3 (SW), L5 (SW) and L1 (MW) to signal grid of V1 and couples L1 between bottom end of L6 and C2 on LW band for use as a loop aerial.

S2 is used to switch L6, the LW tuned coil, to signal grid of V1 and to short circuit C6 (a capacitor in series with tuning capacitor VC1) when on LW and MW bands. S2 also connects C4 across VC1 on the SW ranges.

T1 and T2 are MW and LW trimmers. SW circuits are trimmed by adjustment of iron-dust core only.

R1 is a static drain resistor between aerial input and earth. AVC is applied to V1 on LW and MW bands only through L1 and L6. R5 is AVC feed resistor, and C3 decoupling capacitor. Screen voltage is obtained from R2 decoupled by C5. L7, C7, the primary of IFT1, are in the anode circuit of V1.

**Oscillator** is connected in a tuned grid circuit with series-fed HT on the two SW bands and parallel-fed HT on MW and LW ranges.

L10 (SW), L12 (SW), L13 (MW) and L14 (LW) are the grid coils connected by S3 through C9 to oscillator grid of V1 and to tuning capacitor VC2. S4 short circuits C10, C11, which are in series with VC2, and connects C16 across VC2 when receiver is operating on SW bands. T3, T4, are MW and LW trimmers, and C14, C15 padders. SW circuits are trimmed by adjustment of iron-dust cores.

Bias for oscillator grid is developed on C9 with R3 as grid leak. Feedback voltages for oscillator anode are obtained inductively by L9, L11 on the SW bands and capacitively from C15 on MW and LW bands. To ensure stable operation of oscillator at the high frequency end of the SW bands when the HT battery voltage is low the oscillator HT is series fed through L9, L11 to anode. R4 is oscillator anode load, and C12 anode coupling for MW and LW feedback.

**IF amplifier** operates at 465 Kc/s. L8, C8, the secondary of IFT1, feed signal to grid of IF amplifier V2. AVC, from R10, is fed to grid through L8 and decoupled by C17. Screen voltage is obtained from R2 decoupled by C5. L15, C18, the primary of IFT2, are in the anode circuit of V2.

**Signal rectifier.** L16, C19, the secondary of IFT2, feed signal to one diode of V3. R14, the volume control, is the diode load, and R6, C21 form an IF filter.

**Pickup.** Sockets are fitted across R14 for the connection of a low impedance pickup.

**Automatic volume control.** C20 feeds signal

from primary of IFT2 to second diode of V3. R9 is diode load, and R10 feed resistor. R5, C3, C17 provide AVC line decoupling.

**AF amplifier.** C22 feeds signal from volume control to grid resistor R7 and thence via potentiometer R15 to grid of triode section of V3. R15 with C23 forms the tone control network. Bias for triode grid is developed on C22.

**Output stage** uses a double-pentode operated under quiescent push-pull conditions. C24 feeds signal from anode of V3 to tapping on push-pull driver transformer L17. Negative bias for grids is applied to second tap on L17. R11 is grid bias loading resistor and ensures that the GB voltage falls proportionately to the HT. The opposite-phase signals appearing at ends of L17 are fed through grid stoppers R12 and R13 to grids of V4.

The screens of V4 are internally strapped and obtain their voltage direct from HT line.

HT for anodes of V4 is fed to centre tap of L18, the primary of OP1, the output matching transformer. L19, its secondary, feeds into an eight-inch PM loudspeaker, L19.

Sockets are provided on L19 for connection of a low-impedance extension loudspeaker.

A screw-link on the external loudspeaker panel allows the internal speaker to be silenced.

**High tension** is obtained from a 120V combined HT and GB battery. S6 breaks the HT negative, and GB negative leads to the receiver. C25 provides HT battery decoupling.

**Low tension.** Filaments of V1 to V4 and dial light are parallel-connected and obtain their current from a 2V accumulator. S5, which is ganged to S6 and to the wavechange switches S1 to S4, breaks the LT positive lead to the filaments.

**Consumption.** Quiescent HT, 12.5 mA; LT, 0.6A; GB, -9V.

**Chassis removal.** Unplug loudspeaker lead from receiver chassis. On removal of the two moulded feet at the back of underside of case the chassis is free to be withdrawn.

**Note.** In early models of this receiver the oscillator anode reaction coils were all parallel fed. In these models C12, instead of being connected between bottom of L11 (SW) and L13 (MW), is connected between oscillator anode and top of L9 (SW). Also, the value of R4 will be found to be 22K instead of 10K.

### TRIMMING INSTRUCTIONS

Apply signal as stated below	Tune receiver to	Trim in order stated for max. output
(1) 465 kc/s to grid of V1 via .1 mF capacitor	—	Cores of L16, L15, L8 & L7
(2) 600 kc/s to aerial socket via dummy aerial	500 metres	Core of L13
(3) 1.4 mc/s as above ..	214 metres	T3, T1 and repeat (2) and (3).
(4) 175 kc/s as above ..	1714 metres	Core of L14, L6
(5) 350 kc/s as above ..	856 metres	T4, T2 and repeat (4) and (5)
(6) 9.6 mc/s via 400 ohm non-inductive resistor to aerial socket	9.6 mc/s	Cores of L12, L5
(7) 15.3 mc/s as above ..	15.3 mc/s	Cores of L10, L3

*Note.*—A crystal controlled signal generator, if available, should be used for operations (6) and (7).