

For more information remember www.savoy-hill.co.uk

# EKCO A52

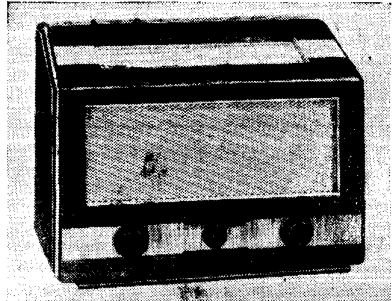

Description and alignment notes, see page 42

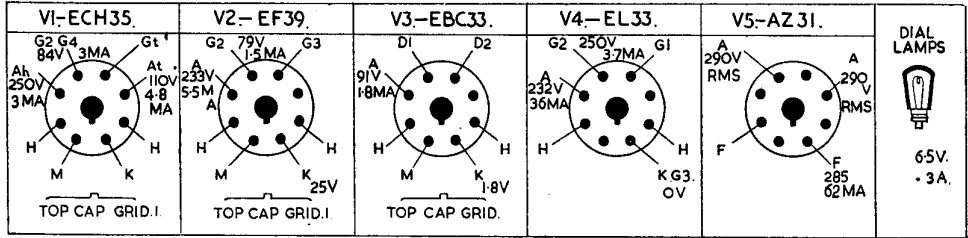
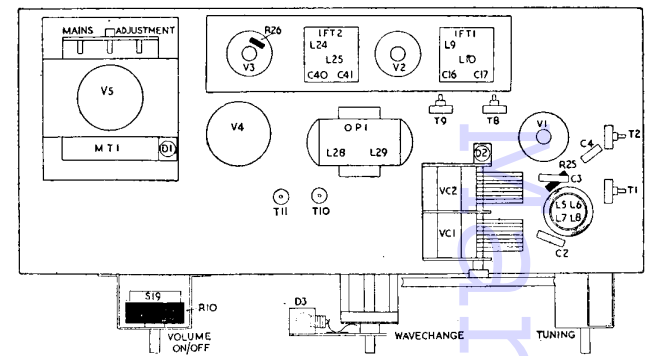
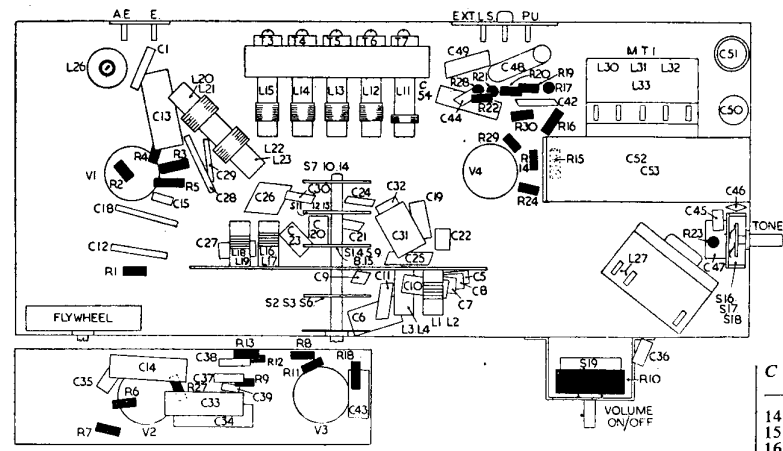

### CAPACITORS

C	Capacity	Type
1	150pF	Silver Mica
2	470pF	Silver Mica
3	820pF	Silver Mica
4	47pF	Tub. Ceramic
5	68pF	Silver Mica
6	1200pF	Silver Mica
7	47pF	Silver Mica
8	100pF	Silver Mica
9	150pF	Silver Mica
10	39pF	Silver Mica
11	56pF	Silver Mica
12	300pF	Silver Mica
13	.1	Tubular 350V
14	.1	Tubular 350V
15	47pF	Tub. Ceramic
16	150pF	Silver Mica
17	150pF	Silver Mica
18	470pF	Silver Mica
19	82pF	Silver Mica
20	240pF	Silver Mica
21	68pF	Silver Mica
22	17pF	Silver Mica
23	300pF	Silver Mica
24	100pF	Silver Mica
25	270pF	Silver Mica
25	1000pF	Silver Mica
27	68pF	Silver Mica
28	570pF	Silver Mica
29	270pF	Silver Mica
30	470pF	Silver Mica
31	820pF	Silver Mica
32	330pF	Silver Mica
33	.1	Tubular 350V
34	.1	Tubular 350V
35	.005	Tubular 500V
36	.005	Tubular 500V
37	100pF	Tub. Ceramic
38	100pF	Tub. Ceramic
39	15 pF	Tub. Mica
40	150pF	Silver Mica
41	150pF	Silver Mica
42	2500pF	Silver Mica
43	5	Tubular 350V
44	160pF	Silver Mica
45	.005	Tubular 500V
46	160pF	Silver Mica
47	270pF	Silver Mica
48	.01	Tubular 500V
49	2000pF	Silver Mica
50	50	Electrolytic 25V
51	4	Electrolytic 500V
52	16	Electrolytic 500V
53	8	Electrolytic 500V
54	.0025	Tubular 500V

### INDUCTORS

L	Capacity	Type	Ohms
1-4			Very Low
5			5
6			14
7			40
8			30
9			9
10			9
11			3.7
12			4
13			3.5
14			2
15			1.8
16-19			Very Low
20			1.2
21			3
22			2
23			6.5
24			9
25			9
26			8.5
27			540
28			480
29, 30, 32			Very Low
31			600 Total
33			43 Total

### RESISTORS

R	Ohms	Watt's
1	680K	
2	47K	
3	33K	
4	33K	
5	22K	
6	100K	
7	2.2K	
8	470K	
9	47K	
10	1M	potr. with switch
11	470K	
12	1.0M	
13	1.5M	
14	33...	
15	68...	
16	10K	
17	47K	
18	1K	
19	22K	
20	22K	
21	470K	
22	470K	
23	470K	
24	470K	
25	330	
26	220K	
27	47K	
28	1M	
29	470	
30	100	

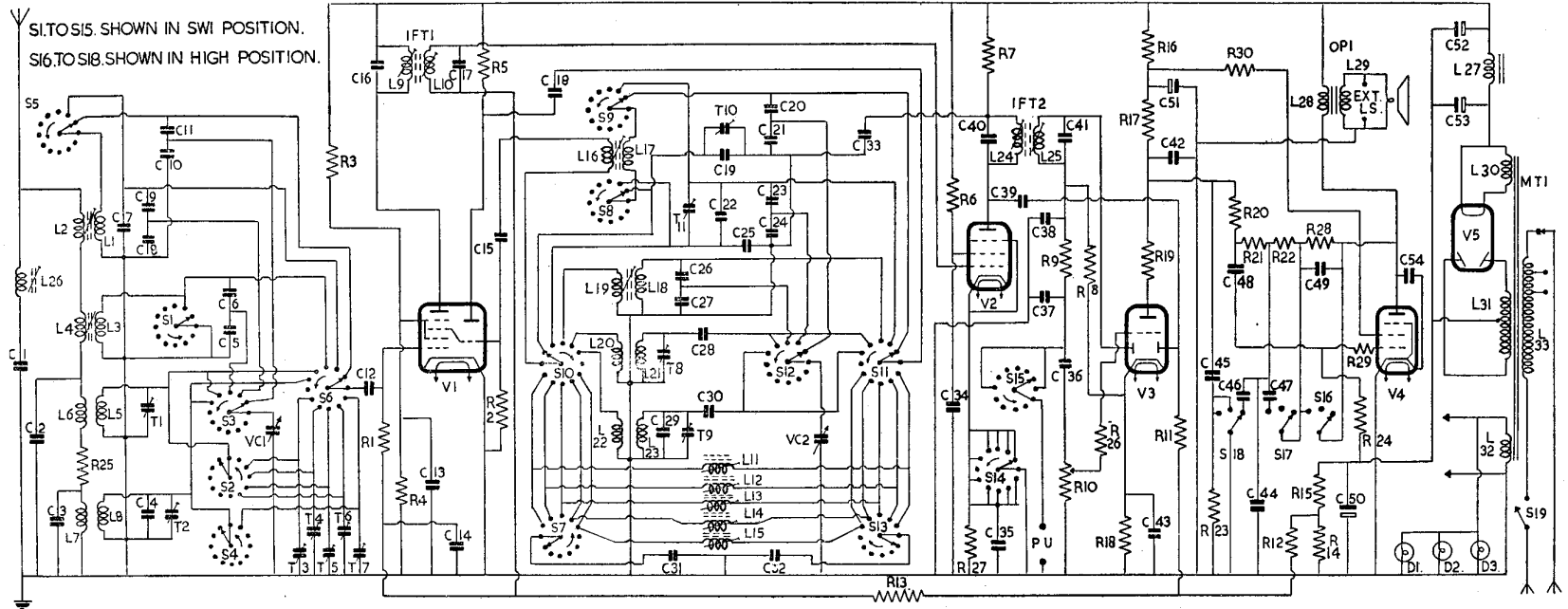

Continued on page 42

## MOTOVIA P45

**A**ERIAL signal is fed through a screened lead, the capacity of which forms C1 to screened filter L1, C2, and thence coupled by C3 to bottom end of aerial coil L2. L2, tuned by VC1 and trimmed by T1, is connected to g4 of octode frequency-shanger V1. AVC and a standing bias decoupled by R1, C4, are fed through L2 to g4. R1, C4, apart from decoupling the AVC line, are also associated with the bottom end aerial coupling circuit. Cathode of V1 is connected down to chassis. Screen (g3, g5) voltage is obtained from R2 and decoupled by C5. Primary L5, C12 of IFT1 are in the anode circuit.

**Oscillator** is connected in a tuned-grid shunt-fed circuit. L3 the grid coil, which is tuned by VC2, trimmed by T2 and padded by C6, is connected to oscillator grid (g1) of V1. R3 is its leak. Anode reaction voltages are developed inductively on L4 and coupled through C7 to oscillator anode (g2) of V1, of which R4 is the load.

**IF amplifier** operates at 460 kc/s. Secondary L6, C13 of IFT1 feeds signal, a standing bias and AVC voltages to g1 of IF amplifier V2. R7, C9 decouple the AVC and bias line to g1. Cathode and suppressor grid (g3) are connected down to chassis. Screen (g2) voltage is obtained from R2 and decoupled by C5. L7, C14, forming the primary of IFT2, are in the anode circuit.

**Signal rectifier.** Secondary L8, C15 of IFT2 feeds signal to one diode of V3. R5, the volume control, is the diode load, and C8 a filter capacitor.

**AVC.** C11 feeds signal from primary L7 of LFT2 to second diode of V3. R8, its load, is connected to bias potential divider R9, R10, in the negative HT return lead to chassis, to provide delay voltage for the AVC diode.

**AF amplifier.** C10 feeds rectified signal appearing across volume control R10 to grid of triode section of V3. Automatic bias for grid is developed on C10 with R6 as leak. R12 is anode load resistor, and C17 anode RF bypass capacitor.

**Output stage.** C16 feeds signal to g1 of beam tetrode output valve V4. Negative bias for grid is obtained by connecting earthy end of grid resistor R11 to R9, R10 in the HT negative lead to chassis. C18 decouples the bias voltage. Cathode is connected down to chassis. L9, the primary of output matching transformer OP1, is in the anode circuit, the HT for which is obtained direct from reservoir capacitor C23.

L10, the secondary of OP1, feeds signal through spark choke L11 and filter capacitor C21 to the separately housed 6-inch PM loudspeaker L12.

**HT** is provided by a full-wave cold-cathode rectifier V5. L13, the HT secondary of the vibrator transformer, supplies its anode voltages. Resistance-capacity smoothing is by R17, C22, C3. R13, C19 are coupled between anodes of V5 to eliminate vibrator noise modulating the receiver signal.

**Heaters and dial light** are wired on two parallel circuits which are connected to sockets on the vibrator holder. With a 12V vibrator the two circuits are series connected to work from the 12V input. When a 6V vibrator is used, then the two circuits are paralleled to work from the 6V input.

Primary of vibrator transformer is formed by L15, which is centre tapped, together with L14, L16. On 12V operation L14, L16 are coupled by the connections on the vibrator base in anti-phase to L15 to give a secondary voltage across L13 of approximately 550V.

On 6V operation, however, L14, L16 are coupled in phase with L15 in order to maintain a secondary voltage of 550. R14, R15 and C24 form a spark quenching circuit.

**Vibrator** is either a 12 or 6V non-synchronous type with a 13-pin base.

Originally this receiver used a 13-pin self-rectifying vibrator which required to be reversed in its socket to suit the earth polarity of the car battery system. With the OZ4 type rectifier becoming available the self-rectifying vibrator was discontinued. The non-synchronous vibrator used will operate on either positive or negative earthed systems whichever way it is plugged in its socket.

**DC input of 12 or 6V** is fed one side direct to chassis via the "steady bar" mounting of the receiver in the car, and the other side through a 10-amp fuse incorporated in the bayonet catch connecting socket of the single battery lead, through spark choke L18 and to on/off switch S1 which is ganged to volume control spindle. The input is provided with bypass capacitors C26, C27, C28. C27 is a reversible electrolytic capacitor. From the switch S1 the 12 or 6V supply is fed to one side of V2, V4 heaters and to vibrator series-parallel socket, and through "hash" filter circuit L17, C25 to centre tap of primary L15 of vibrator transformer.

**Chassis removal.** Unplug battery lead from bayonet-fuse socket in lead and also uncouple LS lead and remove aerial plug. Remove the 13 self-tapping screws at sides of casing. Carefully ease out chassis from case, ensuring that as chassis is withdrawn the LS and battery leads are free to pass through clearance holes at rear of case.

### ALIGNMENT INSTRUCTIONS

Apply Signal as Stated Below	Tune Receiver to	Trim in Order Stated for Max. Output
(1) 460 kc/s to g1 of V1 via .01	—	Core L8, L7, L6, L5.
(2) 1.5 mc/s to AE lead via dummy aerial.	200 metres	T2, T1.
(3) 600 kc/s as above	500 metres	Core L3, L2. Repeat (2) and (3).

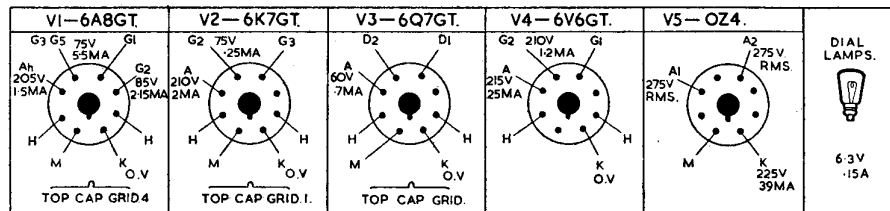

## EKCO A52—from page 40

Five-valve five-waveband superhet with electrical band-spread on SW ranges and five pre-selected stations in addition to manual tuned wavebands. Sockets for high-impedance pickup and low-impedance extension speaker. Walnut veneer table style cabinet. For 200 to 250V 40-100 c/s AC mains. Made by E. K. Cole, Ltd., Southend-on-Sea, Essex.

**A**ERIAL is fed to series-connected coupling coils L2 (SW1, SW2), L4 (SW3), L6 (MW), L7 (LW) and to IF filter circuit L26, C1, C2 (SW) and C3 (MW) are bypass capacitors and R25 an MW damping resistor. The grid coils L1 (SW1, SW2), L3 (SW3), L5 (MW), L8 (LW) are switched by S5, S6 through C12 to g1 of triode-hexode frequency changer V1. S5 is necessary because L1 is used for SW1 and SW2 bands. Aerial tuning capacitor VC1 is switched by S3 to the tuned coils. On SW1, 2 and 3 ranges effective capacity of VC1 is reduced to give bandspread by use of series and shunt capacitors, C5, C6, C7, C8, C9, C10 and C11. S1 short circuits L3 when SW2 band is in use. T1 (MW), T2, C4 (LW) are manual tuning trimmers. On preselected positions of wavechange switch trimmers T3, T4, T5, T6 are connected to L5 for MW stations and T7 to L8 for the LW station.

AVC and standing bias, decoupled by R13, C14 are fed to V1 by R1. L9, C16, which form the primary of IFT1, are in the hexode anode circuit.

**Oscillator.** On SW1, SW2 and preselected stations, Colpitts circuits are used, but for SW3, MW, LW the normal shunt-fed tuned-anode circuit is employed.

The manually tuned coils L17 (SW1, SW2), L18 (SW3), L21 (MW), L23 (LW) are switched by S12 to tuning capacitor VC2 and through S11, C18 to oscillator anode of V1. S8, S9 switch in the series and shunt capacitors C20, C21, C22, C23, C24, C26, C27 across L17, L18, to reduce the effective capacity of VC2 on the three SW ranges. T10, C19 (SW1), T11 (SW2), T8 (MW), T9, C29 (LW), together with adjustable iron cores of L17 (SW1, SW2), L18 (SW3), are used for circuit alignment. The grid reaction voltages, developed inductively on L16 (SW1), L19 (SW3), L20 (MW), L22 (LW), and from L17 (SW2) are switched by S10 through C15 to oscillator grid.

The preselected coils L11 to L15 shunted by C31, C32 are switched by S10, S11 to oscillator anode and grid respectively. R5 is anode load resistor and R2, C15 provide self bias for grid.

**IF Amplifier** operates at 460 kc/s. R27, decoupled by C35, provides a muting cathode voltage when S14 is in the GRAM position.

**Signal rectifier.** L25, C41, the secondary of IFT2, feeds signal to one of diodes of V3. R8 is load.

Sockets are fitted for high-impedance PU. Signal from PU is fed by S15 through C36 to volume control R10. To prevent radio break-through when PU is in use, aerial and oscillator switches S1 to S13 are in open position. In addition to this, S14 brings into circuit R27, C35, which develop a cathode muting voltage to cut off IF amplifier V2.

**AF amplifier.** From R10 the signal is fed through grid stopper R26 to grid of triode section of V3. Cathode bias is provided by R18, decoupled by C43. R17 is anode load and R16, C51 anode decoupling.

**Output stage.** C48 feeds signal through grid stopper R29, to grid of pentode output valve V4.

R24 is grid resistor and bias is obtained from R14, R15 in the negative HT return lead to chassis. C50 is bias decoupler.

L29 supplies an 8-in. PM speaker.

**Negative feedback tone control.**

R19, R20, C42 form a top frequency attenuator and C45 switched by S18, gives additional top cut. R23 is fitted to overcome switch clicks. C44 gives a small top lift, by decoupling some of the inverse voltage feedback at the higher frequencies. R21, R22, R28, C49, together with S16, S17, S18 and C46, C47, provide a three-position tone control giving:—

(1) Top Lift—by increasing decoupling of high frequency inverse voltages by shunting C44 with C46.

(2) Normal—C46 disconnected to reduce top lift and R23 shorted out to increase top cut.

(3) Top and Bass Cut—by shorting R28, C49 and shunting R22 with C47.

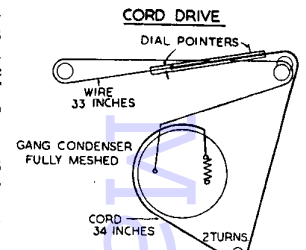

### ALIGNMENT INSTRUCTIONS

Apply signal as stated below	Tune Receiver to	Trim in Order stated for Max. Output
(1) —	MW band with gang condenser fully meshed	Adjust dial pointers to coincide with end scale markings
(2) 460 kc/s to top cap of V1, via .1 mF	As above	Core L25, L24, L10, L9
(3) 1.2 mc/s to AE/E sockets, via dummy aerial	250 metres	T8, T1
(4) 270 kc/s as above...	1111 metres	T9, T2
(5) 7 mc/s as above	42.86 metres	Core L18, L3
(6) 15 mc/s as above ...	20 metres	Core L17
(7) 18 mc/s as above ...	16.67 metres	T11, Core L1
(8) 21.5 mc/s as above	13.9 metres	T10
(9) 460 kc/s as above...	MW band	Core L26 for minimum
<i>Pre-selected Stations</i>		
(1) 1.5 mc/s-1.06 mc/s as above	Position 1	L15, T3
(2) 1.3 mc/s-850 kc/s as above	Position 2	L14, T4
(3) 1.06 mc/s-665 kc/s as above	Position 3	L13, T5
(4) 980 kc/s-560 kc/s as above	Position 4	L12, T6
(5) 250 kc/s-170 kc/s as above	Position 5	L11, T7

Check each setting on station signal for final adjustment.